

21 TWENTY-ONE
YEARS
Of Great Service

SECTION 3

Weatherstripping

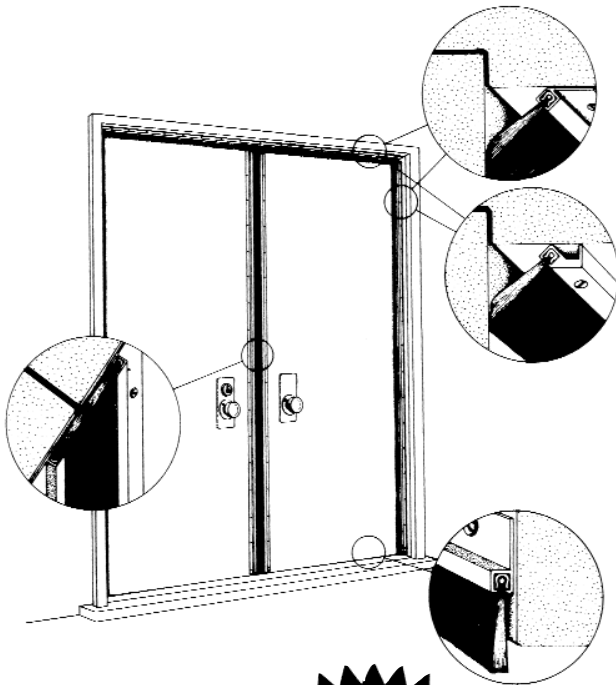

Side view of Header Seal

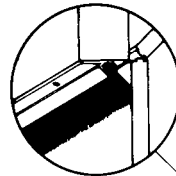

Header Seal

Side view of Header Seal

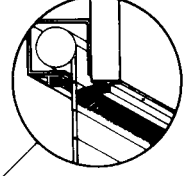

Sectional

Rolling Steel

Top view of Jamb Seal

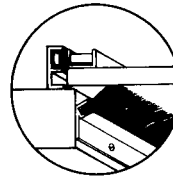

Top view of Jamb Seal

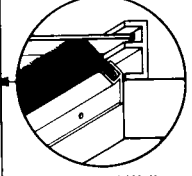

Behind-Wall Installation

Top view of Jamb Seal

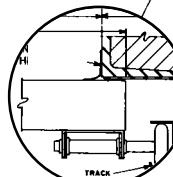

Side view of Door Bottom Seal

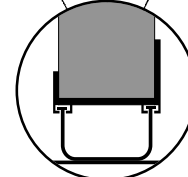

Top view of Jamb Seal

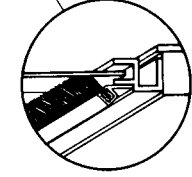

Behind-Wall Installation

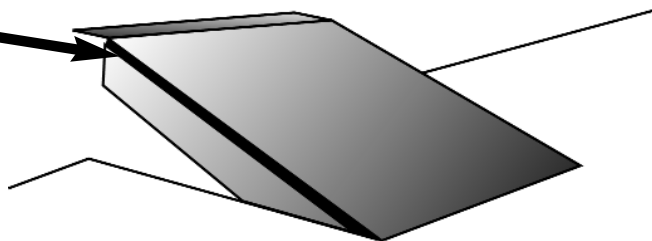
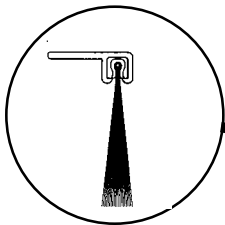

 **American**TM
garage door supply inc.

**We can help you
select the best system.**

1-800-233-1487 Fax: (218) 751-6551

WEATHERSTRIPPING - BOTTOM SEALS

Aluminum Retainer With Bulb Seal

- Black Vinyl Seal
- Won't tear or deform
- Remains pliable in the coldest weather
- Cushions door when closing
- Aluminum holder comes slotted allowing for adjustment and perfect fit.

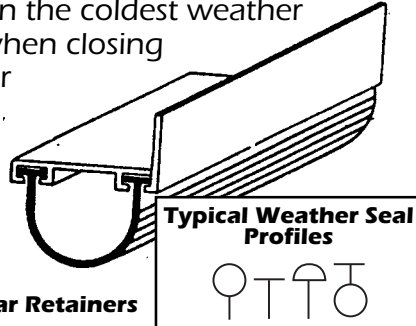

Choose From 2 Popular Retainers



G Type



L Type

Part#	Description	Price
WRG10	Bulb Seal Retainer, T & G Type 10'2"	\$12.50 ea.
WRG12	Bulb Seal Retainer, T & G Type 12'2"	\$15.00 ea.
WRG14	Bulb Seal Retainer, T & G Series 14'2".	\$17.50 ea.
WRL-10	Bulb Seal Retainer, L-Type, 10'2"	\$31.50 ea
WRR-400-V	4" Vinyl Bottom Bulb Seal, T	\$2.25 ft.

Bottom Bulb Seal Also Available In Bulk Rolls

**Need bottom replacement seal for your National Brand door?
Call our professionals and let us help you.**

Bottom Rubber Seal For Wood Doors

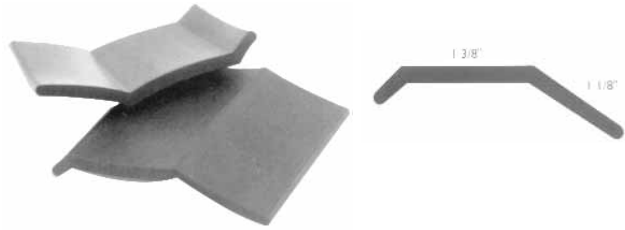

Part#	Description	Price/ft	Price/Roll
WS138	1-3/8" Door Thickness, Soft Sponge	\$1.70	\$130.00
WD138	1-3/8" Door Thickness, Dense Rubber	\$2.00	\$150.00
WD134	1-3/4" Door Thickness, Dense Rubber	\$2.20	\$160.00

Bulk Rolls 100' Lengths

Rolling Steel Bottom Seal

- Dual Durometer Rigid & Flexible
- Standard Colors Black & Grey.

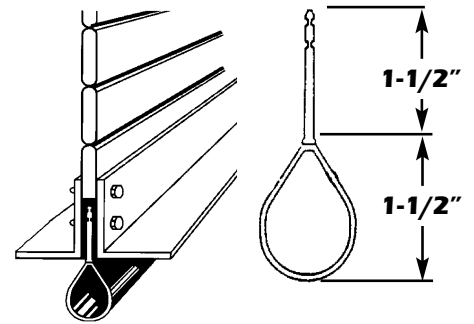

RB-21
\$1.85/ft

Garage Door Threshold

- Solid black vinyl garage door threshold
- Seals out the elements
- Prevents driving rains and snow from backing into the garage
- Helps keep out dirt & leaves
- Keeps door bottom from contact with concrete to prevent rust on metal doors and water damage on wood doors
- Easy to install

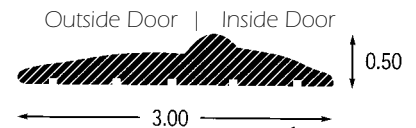
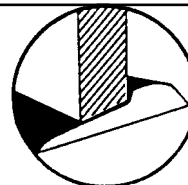

One tube comes with every 20 feet of threshold. Installation works best when temperatures are above 50° F.

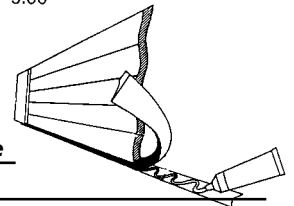

Part#	Description	Price/ Ft.	100 ft. roll
TV35BLN	Threshold	\$5.85	\$526.50

Part#	Description	Price/Tube
TV35	Adhesive only	\$13.00

Top Seal - Sectional

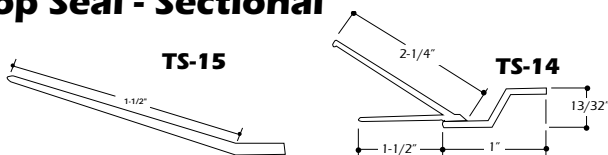

- Rigid and Flexible PVC
- Lengths Cut To Order
- Standard Cut Lengths; 8'2", 9'2", 10'2", 12'2", 14'2", 16'2"
- Standard Color: Black
- Can Be Used On Both Shiplap and T & G Steel Door

Part#	Description	Price/ft
TS-14	Dual Contact Top Seal	\$1.45/ft.
TS-15	Single Contact Top Seal	\$1.35/ft.

Top Seal Caps - Sectional Doors

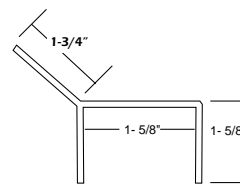

1- 5/8" Top Seal Cap
TC-158
\$2.75/Ft

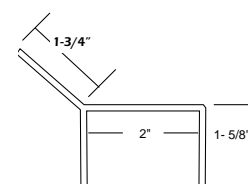

2" Top Seal Cap
TC-200
\$3.00/Ft

WEATHERSTRIPPING - JAMB SEALS

Aluminum/Vinyl Perimeter Seal

- Heavy duty aluminum extrusion with flexible sealing flap.
- Standard mill finish with gray vinyl.
- Eliminates drafts and heat loss.
- Vinyl flap stays flexible in subzero temperatures

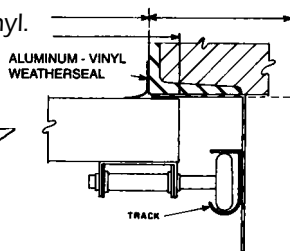
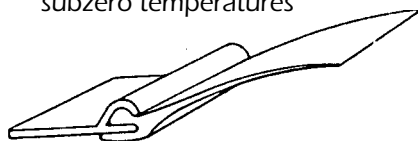

AV21

Standard Sizes 7', 8', 10', 12', 14', 16'

14', 16' Lengths Extrusion Folded in Half with Single Length Blade.
8', 10', 12'- Single Lengths

Part#	Description	Price ea.
AV21-10	1" Aluminum, 2" Vinyl, 10'1"	\$17.50
AV21-12	1" Aluminum, 2" Vinyl, 12'1"	\$21.00
AV21-14	1" Aluminum, 2" Vinyl, 14'1"	\$24.50
AV21-16	1" Aluminum, 2" Vinyl, 16'1"	\$28.00

Note: UPS up to 84" only

Rolling Steel Clip-on Brush Seals

For use on commercial rolling steel doors. The WGS combines a 3/4" plastic guide with efficient brush seal.

Fits 3/16" guides use alone or with epoxy for additional hold.

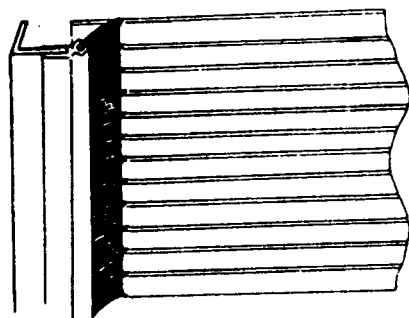

Clips on to guides up to 1/4"

Part#	Description	Price/ft.
WGS10	With 1" Nylon Brush	\$4.55
WGS150	With 1 1/2" Nylon Brush	\$5.55
WGS520	With 2" Nylon Brush	\$6.20
WGS530	With 3" Nylon Brush	\$7.15

Note: UPS up to 84" only

Clip On Vinyl Guide Seal

For Rolling Steel Doors

- Use as vinyl perimeter seal on rolling steel or curtain doors
- Use as bottom seal on curtain doors with double or single angle bottom rails
- Fits 3/16" or 1/4" thick steel angle guides
- Standard gray color
- Standard cut lengths; 8'6", 10'6", 12'6", 14'6", 16'6".

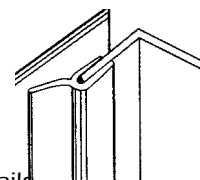

Part#	Description	Price/Box
GS-20-8.5	Clip On Vinyl Seal, 8'6"	\$220.00
GS-20-10.5	Clip On Vinyl Seal, 10'6"	\$275.00
GS-20-12.5*	Clip On Vinyl Seal, 12'6"	\$330.00
GS-20-14.5	Clip On Vinyl Seal, 14'6"	\$385.00
GS-20-16.5	Clip On Vinyl Seal, 16'6"	\$440.00

Available in Unit Quantities of 25 Lengths only
*GS-20-12.5 available as (per ea.) at \$14.00 each.

Reverse Angle Clip-on Vinyl Seal

For use on commercial sectional doors. Dual duometer construction provides a hard vinyl holding section and a flexible flap.

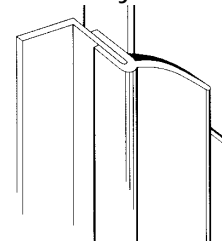
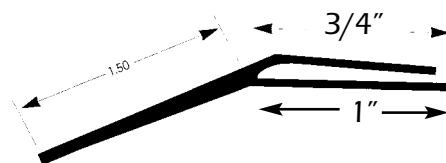

Part#	Description	Price/ft
WRJ-G	Clip-On Vinyl Seal- Gray	\$1.65/ft
WRJ-B	Clip-On Vinyl Seal- Brown	\$1.65/ft
WRJ-W	Clip-On Vinyl Seal- White	\$1.65/ft

Any lengths UPSable

Climate Seals

2" Extruded PVC stop w/ 1" Vinyl Flap.

Will Not Rot, Low Maintenance

Available in white or brown

7', 8', 9', 10', 12', 14', or 16' Lengths

Can be UPS'd in 7' and 8' lengths

Larger sizes and other colors also available

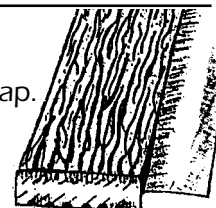

Part#	Description	Price ea.
CS100W-8	Climate Seal, White, 8'	\$14.00
CS100W-10	Climate Seal, White, 10'	\$17.50
CS100W-12	Climate Seal, White, 12'	\$21.00
CS100W-14	Climate Seal, White, 14'	\$24.50
CS100W-16	Climate Seal, White, 16'	\$28.00
CS100B-8	Climate Seal, Brown, 8'	\$14.00
CS100B-10	Climate Seal, Brown, 10'	\$17.50
CS100B-12	Climate Seal, Brown, 12'	\$21.00
CS100B-14	Climate Seal, Brown, 14'	\$24.50
CS100B-16	Climate Seal, Brown, 16'	\$28.00



WEATHERSTRIPPING - BRUSH SEALS

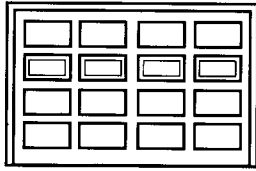

Rolling Steel



High-Speed

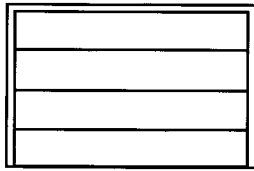

Sectional

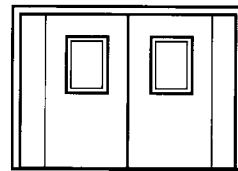

Residential

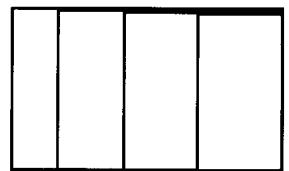

Sliding Aircraft Hangar

- Keeps Out:**
- Drafts
 - Rain
 - Snow
 - Wind
 - Sand
 - Debris
 - Light
 - Noise
 - Insects
 - Rodents
 - Birds
 - Bats

To minimize air dirt infiltration around rolling steel, sectional and sliding doors, install the best weatherseals available. Our brush weatherseals' unique property of conforming to irregular surfaces provides the most effective seal. Thousands of filaments form a solid wall for a complete weather tight seal without impairing door movement.

Standard Commercial Brush Seal

1-1/2" Straight

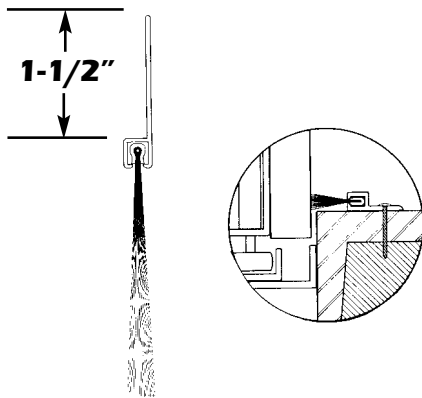

Part #	Brush Type	Length	Price/ft
BPS151	Polypropylene	1"	\$3.90
BPS155	Polypropylene	1.5"	\$4.55
BPS152	Polypropylene	2"	\$4.90
BPS153	Polypropylene	3"	\$5.55

1-1/4" x 45°

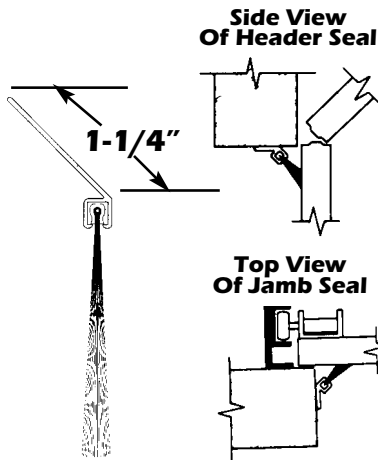

Part #	Brush Type	Length	Price/ft
BP4121	Polypropylene	1"	\$3.60
BP4125	Polypropylene	1.5"	\$4.25
BP4122	Polypropylene	2"	\$4.55
BP4123	Polypropylene	3"	\$5.20

3" Straight

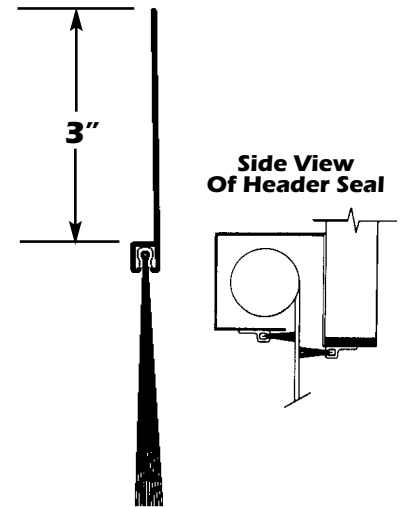

Part #	Brush Type	Length	Price/ft
BPS31	Polypropylene	1"	\$5.20
BPS35	Polypropylene	1.5"	\$5.85
BPS32	Polypropylene	2"	\$6.20
BPS33	Polypropylene	3"	\$6.50

Heavy Duty Commercial Brush Seal

These nylon seals are designed for the largest gap on large sectional, industrial rolling steel and aircraft hangar doors.

	Part #	Brush Type	Length	Price/ft
1-3/8" Straight	GS34	Nylon	1-3/4"	\$12.35
	GS25	Nylon	2-1/2"	\$13.35
	GS30	Nylon	3"	\$14.65
	GS40	Nylon	4"	\$15.95
	GS50	Nylon	5"	\$18.20
1-1/2" 45° Angle	GA34	Nylon	1-3/4"	\$12.35
	GA25	Nylon	2-1/2"	\$13.35
	GA30	Nylon	3"	\$14.65
	GA40	Nylon	4"	\$15.95
	GA45	Nylon	5"	\$18.20
5-1/2" Straight	GLS34	Nylon	1-3/4"	\$14.30
	GLS25	Nylon	2-1/2"	\$15.30
	GLS30	Nylon	3"	\$16.90
	GLS40	Nylon	4"	\$17.90
	GLS50	Nylon	5"	\$20.50

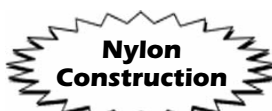

The heaviest seals available anywhere. Our heavy duty brushes seal out the elements around large industrial rolling steel doors, sectional doors, and other large doors including aircraft hangar doors. available in brush lengths up to 7". UL Rating for smoke seals on all brushes up to 4" in length

Aircraft Hangar Brush

Crimped polypropylene brush was developed for special use in sealing aircraft doors. This lower priced brush seals the largest gaps usually associated with hangar doors while providing the advantages of nylon brush weather seal. The brush can be combined with angled or straight holders and is available in brush trim lengths of 2", 3" and 4"

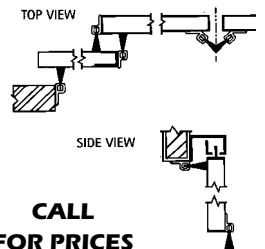
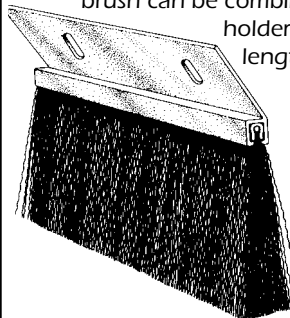

CALL FOR PRICES

2009- 4



American Garage Door Supply Inc.
1-800-233-1487 Fax: (218) 751-6551



Note: Brush seal UPSable up to 84"

WEATHERSTRIPPING - ENTRANCE DOOR SEALS

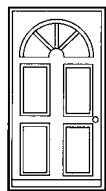

Wood

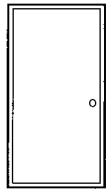

Hollow Metal

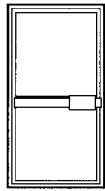

Storefront

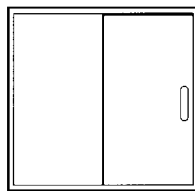

Automatic Sliding

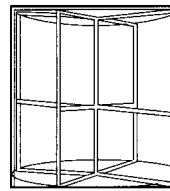

Revolving

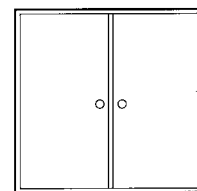

Glass

Keeps Out: • Drafts • Wind • Light • Rain • Insects • Snow • Noise • Sleet • Dust • Fumes • Sand • Rodents

The importance of sealing openings in a building applies to entrance doors just as it does to overhead doors. Any gap around a door causes energy loss due to air infiltration. Dirt and debris are just as much of a problem. Brush designed Door Bottom Seals and Door Jamb Seals provide the most effective means of solving these problems. Mounted using special finished holders, brush weatherseals provide an attractive and effective solution to gaps for any door.

Door Bottom Seal Kits

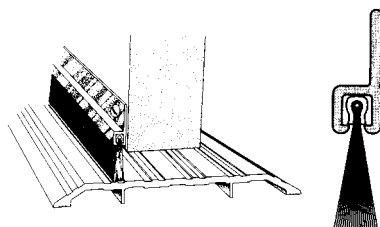

Kit Product Code	Brush Length	Door Bottom Width	Price ea.
A180CLA04BL3	0.41"	3'	\$10.40
A180CLA04BL3.5	0.41"	3.5	12.00
A180CLA04BL4	0.41"	4'	13.65
B210CLA05BL3	0.53"	3'	11.40
B210CLA05BL3.5	0.53"	3.5'	13.00
B210CLA05BL4	0.53"	4'	14.65
C380CLA06BL3	0.59"	3'	12.35
C380CLA06BL3.5	0.59"	3.5'	13.65
C380CLA06BL4	0.59"	4'	15.60
D480CLA09BL3	0.94"	3'	14.95
D480CLA09BL3.5	0.94"	3.5'	17.55
D480CLA09BL4	0.94"	4'	19.85

Other lengths and finishes available

Aluminum door sweeps in both clear and anodized finish with black brush are the perfect compliment to corresponding door jamb seals. The Aluminum holders are pre-slotted for ease of installation and sweeps are prepackaged for fasteners for 3', 3.5' and 4' doors.

Jamb Seal Kits

Kit Product Code	Door Size	Holder Length	Brush Size	Price ea.
JR40CLA04BL17	3' x 7'	.375	.41	\$34.80
JR40CLA04BL18	4' x 7'	.375	.41	36.40
JR40CLA04BL20	6' x 7'	.375	.41	40.65
J135CLA04BL17	3' x 7'	.450	.41	55.25
J135CLA04BL18	4' x 7'	.450	.41	59.80
J135CLA04BL20	6' x 7'	.450	.41	62.40

Kit Product Code	Door Size	Holder Length	Brush Size	Price ea.
J140CLA04BL17	3' x 7'	.750	.41	56.00
J140CLA04BL48	4' x 7'	.750	.41	58.50
J140CLA04BL20	6' x 7'	.750	.41	66.50
VX75BLK				1.95/Ft.

JR40 and J140 kits come with screw slots for after-installation adjustments. J135 kits have countersunk screw holes for a neat flush finish. Fasteners and installation instructions are provided with all kits.

All jamb seals have clear anodized finish. Other finishes are available.

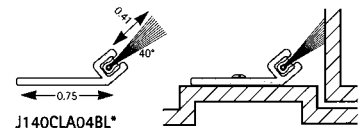
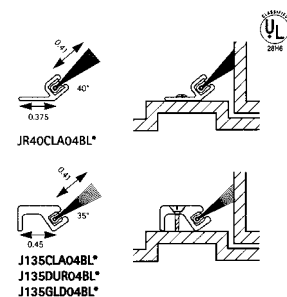

*Brush lengths also available in 0.75" and 1.00".
Adhesive backed silicone rubber "tear drop" is 1 1/2 hour UL rated

Jamb seal kits apply to the header and jamb only.

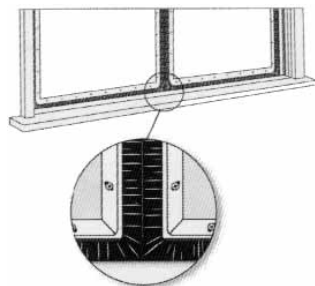

AstraSweep™ corner seals seal the hole between the astragal seal and the door sweep. AstraSweep Kits include two corner seals, two door sweeps and two astragal seals- all the materials necessary to seal the inside (gaps up to 1 inch) and bottoms of a double door. Holders are pre-slotted for easy installation.

AstraSweep™ Jamb Seal Kits

Kit Product Code	Door Size W x H	Finish Color	Price ea.
C380CLA06BL67	6' x 7'	Clear Andodized	97.50
C380DUR06BL67	6' x 7'	Duradonic	122.00
C380CLA06BL68	6' x 8'	Clear Andodized	104.00
C380DUR06BL68	6' x 8'	Duradonic	131.00
C380CLA06BL77	7' x 7'	Clear Andodized	100.00
C380DUR06BL77	7' x 7'	Duradonic	126.00
C380CLA06BL78	7' x 8'	Clear Andodized	108.00
C380DUR06BL78	7' x 8'	Duradonic	135.00
C380CLA06BL87	8' x 7'	Clear Andodized	104.00
C380DUR06BL87	8' x 7'	Duradonic	131.00
C380CLA06BL88	8' x 8'	Clear Andodized	112.00
C380DUR06BL88	8' x 8'	Duradonic	140.00

Corner Seal Kits (3" Legs)

Kit Product Code	Finish Color	Price ea.
C38090CLA06BL	Clear Andodized	38.00
C38090DUR06BL	Duradonic	52.00



WEATHERSTRIPPING - DOCK LEVELER SEALS

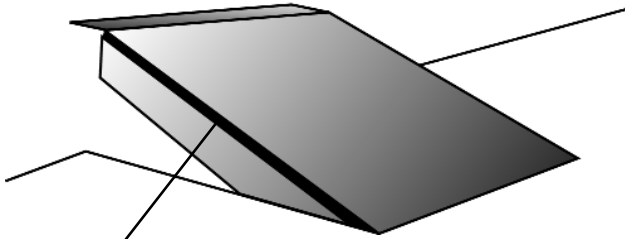

Brush Seals

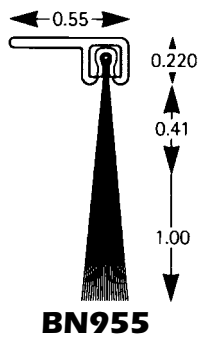

BN955

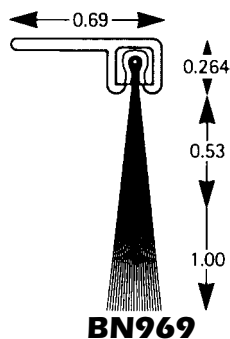

BN969

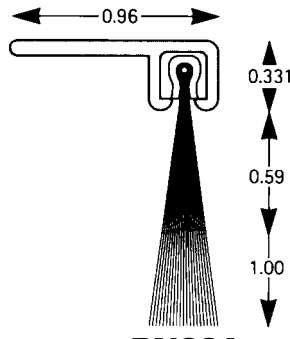

BN996

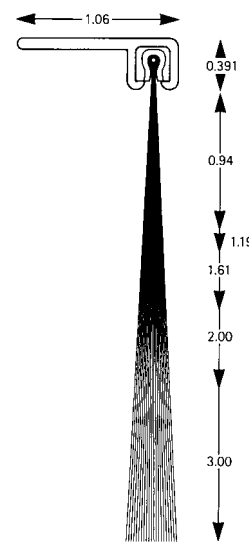

BN916

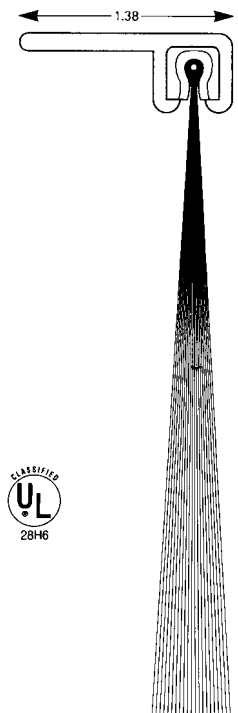

BN913

Part Number	Holder Length	Brush Length	Brush Type	Price Ft.
BN9554	0.55"	.41"	Nylon	\$3.25
BN9551	0.55"	1.00"	Nylon	\$3.90
BN9695	0.69"	.53"	Nylon	\$3.60
BN9691	0.69"	1.00"	Nylon	\$3.90
BN9965	0.96"	.59"	Nylon	\$3.90
BN9961	0.96"	1.00"	Nylon	\$4.25
BN9169	1.06"	.94"	Nylon	\$4.90
BN9161	1.06"	1.19"	Nylon	\$5.20
BN9166	1.06"	1.61"	Nylon	\$5.55
BN9162	1.06"	2.00"	Nylon	\$6.20
BN9163	1.06"	3.00"	Nylon	\$7.15
BN9131	1.38"	1.75"	Nylon	\$12.35
BN9132	1.38"	2.53"	Nylon	\$13.65
BN9133	1.38"	3.00"	Nylon	\$14.65
BN9134	1.38"	4.00"	Nylon	\$15.95

Loading Dock areas present a great opportunity to seal around the many openings of a building. Not only do doors provide areas for air infiltration but the dock levelers themselves can act as wind tunnels robbing a building of heat resources. Our 90° retainer & seal forms the perfect fit for dock leveler seals and other specialty applications. Order your choice of retainer size, brush length and seal width.

Rope Seal

For use in sealing the back portion of a dock leveler. Constructed of neoprene molded in a rope. Our Rope seal is placed near the hinge of a dock leveler and is held in place with hooks. The seal is formed as the leveler lowers compressing against the rope. Order by specifying the length in feet.

RS1ONEOPR..... 3.90/ft



Welded Dock Leveler Brush Seal

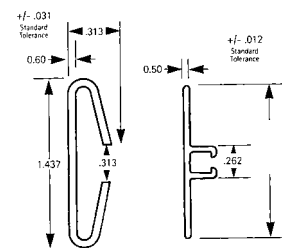

WH15

XTBT90

Part #	Description	Price
WDL71	Welded Dock Leveler Kit \$149.50 ea. for 8' leveler includes: (2- WH15) (2- XTBT90) (2- BN100)	
WDL73	Welded Dock Leveler Kit \$162.50 ea. same as above with 1-1/2" Brush	
WH15	*Weldable Holder (8')	\$32.50/ea.
XTBT90	* T-Retainer (8')	\$15.60/ea.
BN100	1" Nylon Brush only	\$2.30/ft.
BN112	1-1/2" Nylon Brush only	\$3.25/ft.
BT90	1-1/2" Flexible PVC Blade Seal	\$.65/ft.
B90	90° Bracket for Mechanical (Screw On)	\$1.65/ft.

