



**Due to data loss, we as a convenience to our customers,  
have made available our 2001 catalog for you  
to USE AS A PRODUCT REFERENCE only**

**Please Call 1-800-233-1487 For  
Current 2008 Pricing.**

**Thank you for your interest in American Garage Door Supply Inc.**

# Traffic Doors

**WHY  
PAY  
MORE ? ? ?**

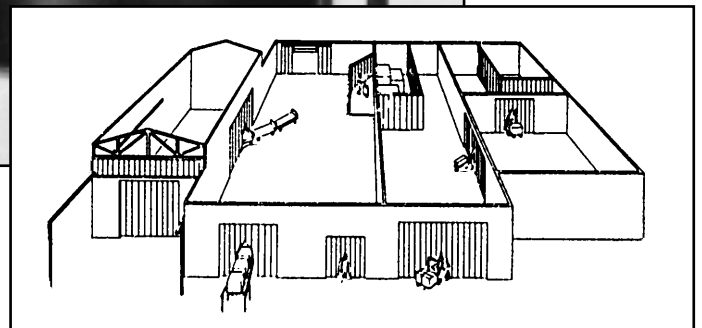
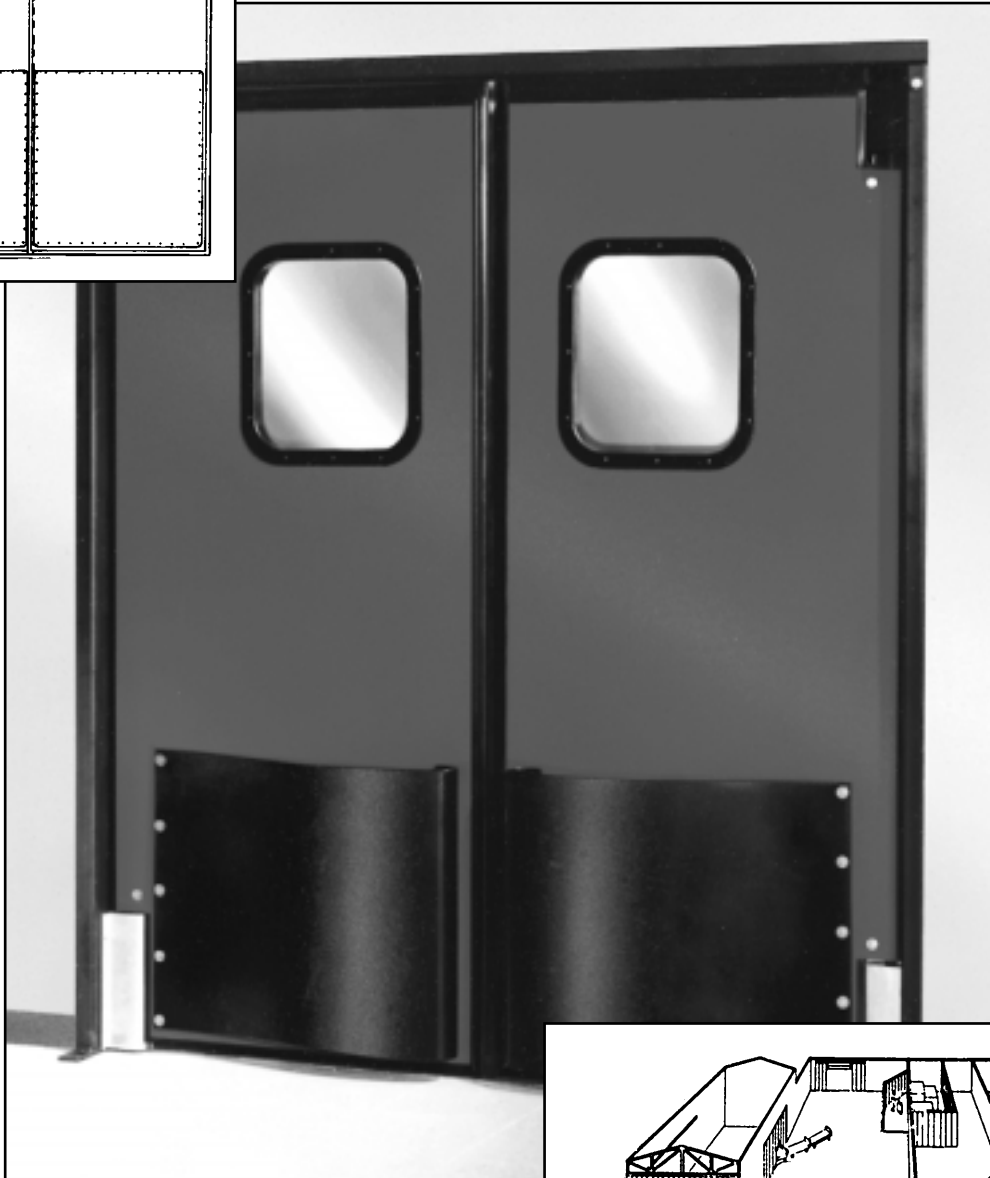
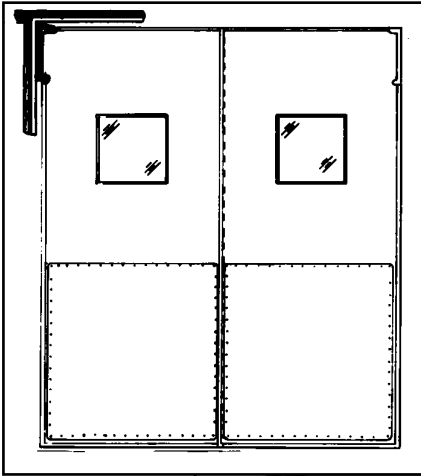

**We can help you  
select the best  
system.**

# TRAFFIC DOORS - IMPACT

## Proline™ Traffic Door

Proline™ Doors are designed for use in industrial, commercial and heavy duty applications where pedestrian & cart or light motorized traffic exists. Applications include stockrooms, prep areas and walk-in coolers. Proline™ doors are NSF listed and USDA approved.

- Strength That Lasts
- Custom Made For Your Exact Opening Size
- Resists Impact Damage
- Practical Window Design

- Superior Edge and Window Seal
- More Covering Options
- Two Year Bumpers
- Extra Wear Protection



## Proline™ Traffic Doors

Proline™ Traffic Doors are engineered specifically to handle the punishment of retail, industrial and commercial applications while continuing to operate smoothly and maintain its appearance for years.

All Proline™ doors incorporate the patented Pro-Loc™ edge system, which on the ABS skin chemically bonds to the ABS edging. This provides a positive seal and prevents moisture or contaminants from entering a door panel. Internal steel reinforcement around the hinge attachment points insures structural integrity, and prevents panel failure in abusive applications. Replaceable bulb gaskets on all perimeter edges are standard. Proline™ doors are designed to comply with all USDA sanitation requirements.

Other features include shatterproof polycarbonate single or double pane vision panels, (Standardized for panel size) heavy-duty gravity return hardware, and lower hinge protection. All Proline™ doors are standard with the patented Proline™ 250° V-Cam hinge system. This unique V-Cam provides a 125° swing in both directions so doors can swing clear of traffic flow even with optional bumpers installed.

### Models 300s and 400s Solid Core Doors

Proline™ solid core doors are engineered specifically to handle the punishment of supermarkets, restaurants, prep rooms, department stores and light industrial areas while continuing to operate smoothly and maintain a good appearance. The Solid Core Doors are constructed of a 3/4" wood core with your choice of skins. These doors are recommended when the temperature differential is less than 30° F.

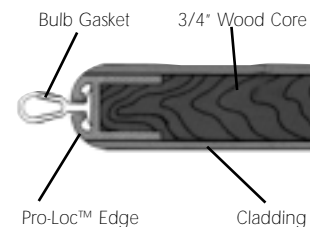

Patented 300s Solid Core Door

### Models 300i and 400i Foam Insulated Doors

Proline series 300i and 400i insulated foam doors are recommended for applications where thermal separation sound attenuation, and sanitary good looks are required. Ruggedly built, Proline™ doors are an excellent choice for walk-ins, meat cutting rooms, refrigerated processing areas or light industrial applications. Proline™ insulated doors are recommended when the temperature differential exceeds 30° F.

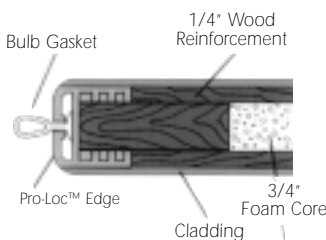

Patented 300i Insulated Door

**Models 300s & 300i** - ABS high-impact plastic FRP, or high pressure laminate in a variety of colors.

**Models 400s & 400i** - Stainless Steel, Galvanized Steel, or Anodized Aluminum.

### Product Options: (See page 35)

- Full length steel reinforced spine recommended for heavy duty applications
- Impact plates
- Roto-molded Tear-drop Bumpers
- Cart Guards
- Vision Panel Sizes 8" x 16", 10" x 16", 16" x 16", 17" x 23", and 23" x 23"
- Locking Devices
- E series hinge for light duty operations

	Width	300s 400s Solid Core No Options	Add-on With 42" Tear-Drop Spring Bumpers	300i 400i Foam Core No Options	With 42" Tear-Drop Spring Bumpers
84" H Single Doors	30"	\$605	N/A	\$720	N/A
	36"	\$661	\$890	\$770	\$995
	42"	\$690	\$918	\$800	\$1024
84" H Double Doors	60"	\$1145	N/A	\$1385	N/A
	72"	\$1262	\$1721	\$1474	\$1933
	84"	\$1315	\$1773	\$1535	\$1990
90" H Double Doors	60"	\$1228	N/A	\$1460	N/A
	72"	\$1348	\$1804	\$1555	\$2011
	84"	\$1400	\$1858	\$1613	\$2072
96" H Double Doors	60"	\$1311	N/A	\$1538	N/A
	72"	\$1430	\$1888	\$1633	\$2092
	84"	\$1544	\$1943	\$1695	\$2151

Note: Above prices include 42" standard spring bumpers – Add \$523.00 for heavy duty spring bumpers.

Single doors- Please specify Right Hand or Left hand Warranty requires limiting posts and/or door stops.

## Other Sizes Available!

For Stock & Prep Room Areas

For Walk-in Coolers

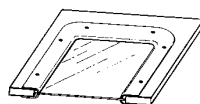

Models 300s, 400s

Shatterproof  
Polycarbonate  
Single pane window

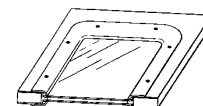

Models 300i, 400i

Shatterproof  
Polycarbonate  
Double pane window



## Duralite® Standard Traffic Door

Duralite® Standard Doors are designed for use in tough industrial, commercial, institutional and retail applications. This product is rotationally molded out of crosslinked polyethylene and is designed to work in temperatures as low as -40° F.

- **Monolithically Molded 1/8" Thick "Cross Linked" Polyethylene Molded Construction**
- **Sixteen Standard Colors**
- **Molded in Window Design**
- **13 Ga. Internal Steel Reinforcement**
- **Standard Door Opening Sizes Only**
- **Non-CFC Urethane Foam Core**
- **Corrosion Resistant**
- **Heavy Duty V-Cam Hinging System**
- **Sizes up to 7' x 8'**

**New**

**Unmatched Quality**



## Duralite® Standard Doors Insulated Impact Traffic Doors

The Duralite® line of insulated impact traffic door is designed for use in commercial, industrial, and retail applications. They are used where aesthetic appeal, thermal separation, and sound attenuation are considerations and where heavy traffic flow exists.

All Duralite® semi-rigid double-acting doors feature a patented monolithic (one piece) molded construction with an 1/8" cross linked polyethylene outer skin, which will retain its properties to -40° F. The Duralite door body has no gaps and is impervious to moisture, acids, petroleum products, animal fats, rodents, insects, or salt solutions.

Duralite® door panels are foamed-in-place with high density non-CFC urethane foam and are available in partially or fully gasketed models. All gaskets are easily replaceable without the use of rivets, screws, or other fasteners.

Duralite® door panels are specially constructed of lightweight materials, so they open easily, operate smoothly, and allow for damage free, safe passage for personnel and equipment. All Duralite insulated impact traffic doors operate on a cam lift action, gravity return mechanism that can be supplemented by an optional spring assist where necessary.

The Duralite® impact traffic doors are available in sixteen standard colors and can be equipped with numerous options, including spring bumpers, impact plates, lower hinge guards, double pane windows, locking devices, etc. Extended top seals and molded transom panels can be utilized to close off excessive height in openings equipped with Duralite® doors.

### Code Compliance

Duralite® doors meet codes and limits imposed by the USDA and M.I.D. Copies of certificates are available upon request. Duralite™ doors also conform fully to the Uniform Building Code (UBC).

### Viewing Area

Each window is 1/8" polycarbonate with a black frame. All view windows are factory installed and sealed. The exposed surface of the window is recessed a minimum of 1/8" from the face of the door to protect the surface from abrasion caused by passing loads. The viewing area exceeds the 200 sq. in. UBC requirements.

### Window sizes (included) are as follows:

24" and 27" panels .....	10-1/2" x 22-1/2"
30" panel .....	14-1/2" x 22-1/2"
32" panel .....	16-1/2" x 22-1/2"
34" panel .....	18-1/2" x 22-1/2"
36", 39 1/2", 42", 48" panel.....	20-1/2" x 22-1/2"
54" and 60" panel.....	22-1/2" x 22-1/2"

### Product Options:

- V-Cam hold open devices
- Double-pane windows for use when temperature differential between rooms exceeds 30° F
- Flexible top and bottom hinge seals for partially gasketed doors
- Door stops or limiting posts
- Single and double-door locking devices
- Lower hinge guards
- Spring-assisted hinges
- 180° x 90° door hinge system for use when vehicles must make extremely tight turns after passing through the door. The system includes the door hinges, a spring assist, and a lower hinge guard.
- High-impact, cross-linked polyethylene bumpers with 3" or 4" projection in heights of 12", 18", 24", 36", 38" and 42". Various colors available.
- Flush kick plates of high-impact polyethylene or stainless steel.
- See page 35 for options

### Warranty

A two-year warranty against door panel breakage is offered on Duralite® standard doors not subjected to worker-ridden vehicle traffic with the use of limiting posts and/or door stops except where adjacent walls at 90° act as a limiting device. All warranties stipulate correct installation and sizing requirements.

Single Panels			Double Panels		
Part #	Size	Price	Part #	Size	Price
3678S	3'0" x 6'6"	\$811.00	4878SD	4'0" x 6'6"	\$1320.00
3680S	3'0" x 6'8"	\$831.00	4884SD	4'0" x 7'0"	\$1405.00
3684S	3'0" x 7'0"	\$847.00	4890SD	4'0" x 7'6"	\$1445.00
4278S	3'6" x 6'6"	\$859.00	4896SD	4'0" x 8'0"	\$1485.00
4284S	3'6" x 7'0"	\$814.00	7278SD	6'0" x 6'6"	\$1585.00
4290S	4'0" x 7'6"	\$844.00	7280SD	6'0" x 6'8"	\$1609.00
4884S	4'0" x 7'0"	\$1042.00	7284SD	6'0" x 7'0"	\$1710.00
4890S	4'0" x 7'6"	\$1072.00	7290SD	6'0" x 7'6"	\$1665.00
4896S	4'0" x 8'0"	\$1103.00	7296SD	6'0" x 8'0"	\$1710.00
			7978SD	6'7" x 6'6"	\$1656.00
			7984SD	6'7" x 7'0"	\$1710.00
			7990SD	6'7" x 7'6"	\$1749.00
			7996SD	6'7" x 8'0"	\$1794.00
			8478SD	7'0" x 6'6"	\$1683.00
			8484SD	7'0" x 7'0"	\$1738.00
			8490SD	7'0" x 7'6"	\$1777.00
			8496SD	7'0" x 8'0"	\$1823.00

**Other Sizes Available  
Please Call for Quotation**

Prices above are for Fully Gasketed models.  
For partial gasketed models Please call for quote

# TRAFFIC DOORS - IMPACT

## Durulite® Industrial Traffic Door

Durulite® Industrial Traffic Doors are designed to withstand punishment from worker driven vehicles and cargo. An excellent choice for your toughest areas

- Monolithically Moulded 1/8" Thick Cross Linked Polyethylene Construction
- Sixteen Standard Colors
- Molded in Window Design
- 11 Ga. Internal Steel Reinforcement
- Standard Door Sizes Only

- Non-CFC Urethane Foam Core
- Corrosion Resistant Stainless Steel & Ductile Iron lower Hinge Assembly
- Sizes up to 10' x 10'
- Designed Specifically to Withstand Punishing Worker Ridden Vehicle Traffic

**New**



**Unmatched Quality**

### Product Options:

- V-Cam hold open devices
- Double-pane windows for use when temperature differential between rooms exceeds 30° F
- Flexible top and bottom hinge seals for partially gasketed doors
- Door stops and limiting posts.
- Single and double-door locking devices (locks not included)
- Lower hinge guards
- Spring-assisted hinges
- 180° x 90° door hinge system for use when vehicles must make extremely tight turns after passing through the door. The system includes the door hinges, a spring assist, and a lower hinge guard.
- High-impact, cross-linked polyethylene bumpers with 3" or 4" projection in heights of 12", 18", 24", 36", 38" and 42", various colors available.
- Flush kick plates of high impact polyethylene or stainless steel.

**For Option Prices Please See Page 35**

### Warranty

A one-year warranty against door panel breakage is offered on Durulite® Industrial doors subject to worker-ridden vehicle traffic with the use of limiting posts and/or door stops except where adjacent walls at 90° act as a limiting device. All warranties stipulate correct installation and sizing requirements.

## Durulite® Industrial Doors Extra Heavy-Duty Gasketed Doors

These Durulite® doors have monolithic 1/4" thick, cross-linked polyethylene outer skin and incorporate extra heavy duty hardware and internal steel members. Designed to withstand punishment from worker-ridden vehicles and cargo, this door carries a conditional one-year warranty against panel breakage when installed as recommended by our factory.

Durulite® doors also provide a very effective seal, as they are foamed-in-place and have a full perimeter gasketing. This product is traditionally used in supermarkets and industrial applications such as warehouses, food processing and pharmaceuticals.

Part #	Size	Price	Part #	Size	Price
6078XD	5'0" x 6'6"	\$1878.00	7984XD	6'7" x 7'0"	\$2076.00
6084XD	5'0" x 7'0"	\$1920.00	7990XD	6'7" x 7'6"	\$2128.00
6090XD	5'0" x 7'6"	\$1965.00	7996XD	6'7" x 8'0"	\$2185.00
6096XD	5'0" x 8'0"	\$2015.00	8478XD	7'0" x 6'6"	\$2071.00
6478XD	5'4" x 6'6"	\$1901.00	8484XD	7'0" x 7'0"	\$2137.00
6484XD	5'4" x 7'0"	\$1942.00	8490XD	7'0" x 7'6"	\$2185.00
6490XD	5'4" x 7'6"	\$1985.00	8496XD	7'0" x 8'0"	\$2241.00
6496XD	5'4" x 8'0"	\$2038.00	9684XD	8'0" x 7'0"	\$2260.00
6878XD	5'8" x 6'6"	\$1922.00	9690XD	8'0" x 7'6"	\$2328.00
6884XD	5'8" x 7'0"	\$1964.00	9696XD	8'0" x 8'0"	\$2395.00
6896XD	5'8" x 8'0"	\$2059.00	10884XD	9'0" x 7'0"	\$2390.00
7278XD	6'0" x 6'6"	\$2004.00	10890XD	9'0" x 7'6"	\$2470.00
7284XD	6'0" x 7'0"	\$2057.00	10896XD	9'0" x 8'0"	\$2549.00
7290XD	6'0" x 7'6"	\$2102.00	108102XD	9'0" x 8'6"	\$2630.00
7296XD	6'0" x 8'0"	\$2159.00	12096XD	10'0" x 8'0"	\$2705.00
7978XD	6'7" x 6'6"	\$2076.00	120102XD	10'0" x 8'6"	\$2796.00

**Other Sizes Available  
Please Call for Quotations**

**Prices above are for Fully Gasketed models.  
Partially Gasketed Models Please Call for Quote**

### Code Compliance

Durulite doors meet codes and limits imposed by the USDA, and M.I.D. Copies of certificates are available upon request. Durulite doors also conform fully to the Uniform Building Code.

### Viewing Area

Each window is 1/8" polycarbonate with a black frame. All view windows are factory installed and sealed. The exposed surface of the window recessed a minimum of 1/8" from the face of the door to protect the surface from abrasion caused by passing loads. The viewing area exceeds the 200 sq. in. UBC requirements.

### Window sizes (included) are as follows:

24" and 27" panels.....	10-1/2" x 22-1/2"
30" panel .....	14-1/2" x 22-1/2"
32" panel .....	16-1/2" x 22-1/2"
34" panel .....	18-1/2" x 22-1/2"
36", 39 1/2", 42", 48" panel.....	20-1/2" x 22-1/2"
54" and 60" panel.....	22-1/2" x 22-1/2"

# TRAFFIC DOORS - OPTIONS

## Proline™ Traffic Door Options

	Single Doors	Double Doors
No Gaskets Subtract	(\$15)	(\$30)
Partially Gasketed Subtract	(\$10)	(\$20)
Stainless Steel Push Plates	\$32	\$64
Pull Handles (one side only)	\$56	\$113
Steel reinforced spine lock sleeve	\$81	\$162
Reinforced Steel Jamb	\$219	\$289
Cane Bolts	\$63	\$126
Window Security Bars	\$95	\$190
<b>Oversized Windows</b>		
16"W x 16"H (Panels over 30"W)	\$30	\$60
17"W x 23"H (Panels over 30"W, 84"H)	\$40	\$80
23"W x 23"H (Panels over 30"W 84"H)	\$50	\$100
<b>Lower Hinge Guards</b>		
9"	\$38	\$76
12"	\$45	\$90
18"	\$60	\$120
<b>Heavy Duty Formed Spring Bumpers</b>		
Black, brown green or grey		
18"		\$70
24"		\$59
30"		\$144
36"		\$127
42"		\$287
<b>Impact Plates</b>		
Price includes covering both front and back Black, brown forest green & pewter grey		
Polyethylene	\$10/sq. ft.	
18 guage Stainless Steel	\$18/sq. ft.	
16 guage Stainless Steel	\$10/sq. ft.	
Aluminum Diamond plate	\$25/sq. ft.	

## Durulite® Standard Traffic Door Options

	Single Doors	Double Doors
Hold Open Device (not recommended with Spring Assist)	\$19.00	\$38.00
Spring Assist (for wind condition or negative air pressure)	\$20.00	\$40.00
Lower Hinge Guards - 8.5" standard	\$20.00	\$40.00
Lower Hinge Guards - 11" (for use with spring assist)	\$30.00	\$60.00
Lower Hinge Guards with BASE - 11"	\$66.00	\$132.00
Top seal - (for partially gasketed doors up to and including 6" gap)	\$8.00/ft.	
Extended top seal (for openings having more than 6" gap)	\$24.00/ft.	
1/2" Lock Sleeve - cable with bushings ( lock by others)	\$20.00	\$40.00
2" Lock sleeve - no cable or lock	\$45.00	\$90.00
180 x 90 Degree V-Cam & Hardware (includes lower hinge guards & spring assist)	\$165.00	\$330.00
90 Degree Door Stops (2 per panel) New style 90° & higher opening	\$120.00	\$170.00
90 Degree Door Stops (2 per panel) Old style All opening heights	\$135.00	\$170.00
Double Pane View Windows (for use when ambient temperature between areas is 30 degrees or more. Not for use on freezer doors.)	\$48.00	\$96.00
Cut Charges - consult factory for correct sizing		
Straight	Consult Factory	Consult Factory
Notch	Consult Factory	Consult Factory

**Note:** 3-1/2" minimum wall thickness for standard Lower Hinge Guard  
5-1/2" minimum wall thickness for industrial Lower Hinge Guard and or Spring Assist.

## Durulite® Industrial Traffic Door Options

	List Price Per Opening
Hold Open Device (not recommended with Spring Assist)	\$38.00
Spring Assist (for wind condition or negative air pressure)	\$38.00
Lower Hinge Guards - 11"	\$56.00
Lower Hinge Guards with Base - 11"	\$124.00
Extended Top Seal (for openings having more than 6" gap)	\$22.00/ft.
1/2" Lock Sleeve - cable with bushings ( lock by others)	\$38.00
2" Lock Sleeve - no cable or lock	\$85.00
180 x 90 Degree V-Cam & Hardware includes lower hinge guards & spring assist	\$320.00
90 Degree Door Stops (4 each) New style 90° & higher opening	\$234.00
90 Degree Door Stops (4 each) Old style All opening heights	\$234.00
Double Pane View Windows for use when ambient temperature between areas is 30 degrees or more. Not for use on freezer doors.	\$90.00
Cut Charges - consult factory for correct sizing	
Straight	Consult Factory
Notch	Consult Factory
Louvers	Consult Factory
Stainless Steel Kickplates	Consult Factory
Cane bolts ( 2 each, specify upper or Lower)	\$137.00

### STANDARD DURALITE® DOORS

#### Spring Bumpers or Kickplates Available in all colors - Polyethylene

STANDARD Openings under 7'0" wide		INDUSTRIAL Openings under 7'0" & wider (single panel 42" and wider)	
Single	Double		
\$40.00	\$140.00	6" High	
\$98.00	\$196.00	12" High	\$267.00 set of four
\$130.00	\$260.00	18" High	\$346.00 set of four
\$170.00	\$340.00	24" High	\$427.00 set of four
\$215.00	\$430.00	36" High	\$587.00 set of four
\$235.00	\$470.00	42" High	\$664.00 set of four

### INDUSTRIAL DURALITE® DOORS

#### Industrial Spring Bumpers

**Standard Door Bumpers** (under 7'0" wide have 3" projection)  
**Industrial Bumpers** (7'0" & wider have 4" projection)  
**Available in all colors - Polyethylene**

12" High	\$255.00 set of four
18" high	\$331.00 set of four
24" high	\$405.00 set of four
36" high	\$560.00 set of four
42" high	\$630.00 set of four

#### Limiting Posts

LP 42 Post Foamed complete	\$71.00
LP 42 Post without foam	\$62.50
MP 19 Post	\$41.00

# TRAFFIC DOORS - FLEXIBLE TRAFFIC

## Uniflex® 240 Flexible Traffic Door

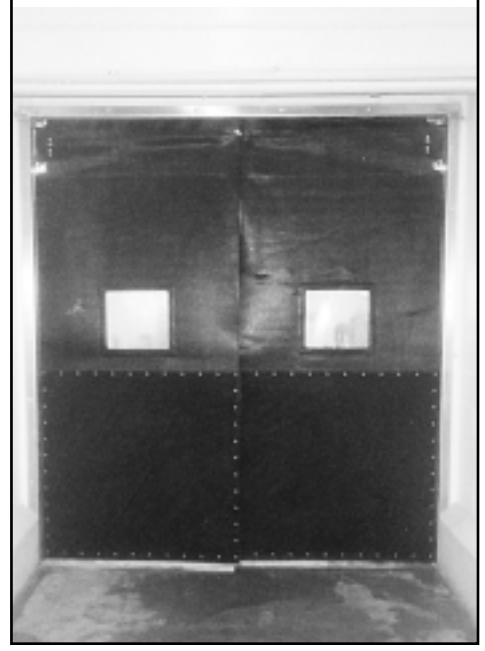

### UNI-FLEX™ 240

The Uni-Flex® 240 Flexible Swinging Door is constructed to meet USDA requirements. It is fabricated of two layers of .120" PVC heat welded together to a thickness of .240". It is available in 8 decorative colors and is embossed with an attractive pebble grain finish.

Uni-Flex 240 windows consist of optically clear, flexible PVC heat welded within the door plies and centered 60" above floor level. Supporting each panel is the top mounted gravity hinge with lifetime replacement warranty.

For extreme usage optional impact plates are recommended.

Note: USDA approval available to 10'0" high only.

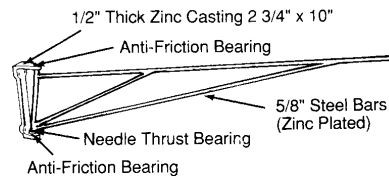

### Top Mounted Lifetime Hinge

This top mounted gravity hinge may be the last you'll ever buy. The hinge is 1/2" cast zinc with 5/8" zinc plated steel rod separated by roller bearings allowing for easy opening and automatic gravity closing. This hinge comes with a lifetime warranty

### SINGLE PANEL                      DOUBLE PANEL

	Width									
	2'0"	2'6"	3'0"	3'6"	4'0"	4'0"	5'0"	6'0"	7'0"	8'0"
4'0"	\$187	\$252	\$280	\$301	\$343	\$406	\$545	\$604	\$650	\$740
4'6"	\$201	\$266	\$296	\$345	\$358	\$432	\$575	\$634	\$681	\$772
5'0"	\$216	\$281	\$309	\$329	\$374	\$465	\$606	\$667	\$712	\$808
5'6"	\$231	\$295	\$328	\$345	\$381	\$497	\$636	\$700	\$747	\$824
6'0"	\$244	\$309	\$340	\$395	\$426	\$528	\$668	\$732	\$855	\$921
6'6"	\$260	\$326	\$364	\$412	\$440	\$559	\$698	\$761	\$888	\$951
7'0"	\$279	\$350	\$381	\$428	\$456	\$614	\$752	\$824	\$923	\$982
7'6"	\$299	\$368	\$399	\$449	\$470	\$645	\$797	\$843	\$957	\$1015
8'0"	\$319	\$387	\$406	\$450	\$485	\$691	\$834	\$874	\$972	\$1048
8'6"	\$333	\$400	\$421	\$462	\$518	\$720	\$864	\$909	\$1020	\$1119
9'0"	\$347	\$414	\$435	\$488	\$534	\$751	\$896	\$939	\$1054	\$1154
9'6"	\$363	\$429	\$450	\$502	\$550	\$783	\$926	\$973	\$1084	\$1187
10'0"	\$376	\$444	\$464	\$526	\$566	\$814	\$958	\$1003	\$1135	\$1222
48" High Impact Plates (optional)										
HTP-90 48"	\$98	\$122	\$147	\$148	\$198	\$196	\$245	\$294	\$342	\$391

### Panel & Kickplate Colors Available;

Brown, black, suntan, royal blue, navy, pewter gray, forest green & red

### Replacement Parts (F.O.B. Factory)

Door Panels .....\$16.50 sq. ft.  
 Door Hinges .....\$80.00 ea  
 HTP-90 48" Impact Plates.....\$12.00 sq. ft.

### Upgrade Options

Transom Fixed or Hinged .....Please Call  
 Adjustable Hinge .....Please Call  
 V-Cam Rise Hinge .....Please Call

PVC is not intended for extremely cold or low temperature applications. Other materials are available for these applications. **Please Call for Quote.**



## Strip Doors

Our strip doors are designed to provide a flexible barrier to help isolate your employees and areas from unwanted dust, noise pollution, insects and more.

- Strip Doors are inexpensive and usually pay for themselves in less than one year
- Unique Bi-MOUNT™ and J-Hook™ mounting system makes installation and strip replacement fast and easy.
- Patented “J-Hook” mounting hangars are heat sealed to each individual strip for better support and longer strip life.
- Largest selection of strip material sizes, colors, types and grades in the industry.

## There's a place for a Strip Door in your Facility

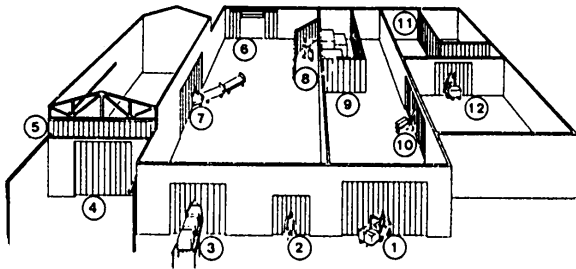

- |                                   |                                      |
|-----------------------------------|--------------------------------------|
| 1. Loading dock receiving door.   | 8. Welding Screens                   |
| 2. Personnel doors                | 9. Storage Area Enclosures           |
| 3. Conveyor Openings              | 10. Temperature Control Rooms        |
| 4. Large Exterior Receiving Doors | 11. Noise Reducing Machine Enclosure |
| 5. Craneway Enclosures            | 12. Traffic Doors                    |
| 6. Combination With Airscreen     | 13. Traffic Door Barriers            |
| 7. Partitions Between Rooms       |                                      |

### There's a Strip Door for your Application.

We offer the industry's widest range of strip door products. Our easily-installed, easily-maintained Bi-mount™ hardware is adaptable to practically any application. That's why for over 14 years, warehouses, food service facilities, and manufacturing plants have turned to us when traffic demands an open door.

- |                               |                            |
|-------------------------------|----------------------------|
| • Noise Barriers              | • Conveyor Openings        |
| • Animal Doorways             | • Refrigerated Cases       |
| • Welding Booths              | • Clean Rooms              |
| • Loading Docks               | • Craneways                |
| • Interior Partitions         | • Walk-in Coolers/Freezers |
| • Chip barriers for Machining | • Refrigerated Truck Doors |

## Mounting

### Flush Wall Mounting

Mounts above opening with extra height and width to provide overlap at sides.

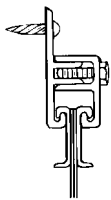

- Flush Wall Fixed Hang
- In-jamb Fixed Hang
- Gravity Hinge
- Movable in-Truck Mount

### In-Jamb Mounting

Mounts to brackets beneath the header or lintel when flush wall mounting is impractical

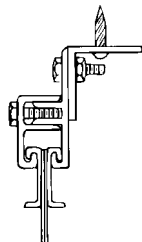

- Trolley Mount
- Gate Hinge
- Overhead Rollup

## J-Hook-Strip Mounting Is Faster & Stronger

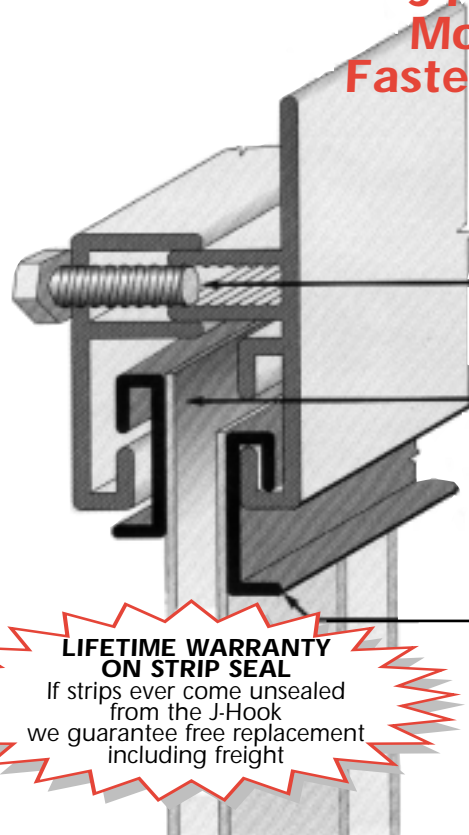

Fast bolt-together system clamps strips into place with perfect overlap

J-hook or Pin Mounted strips simply hang on to mounting bracket for easy installation or replacement

J-hook Design prevents ripping typical of pin/clip design

### LIFETIME WARRANTY ON STRIP SEAL

If strips ever come unsealed from the J-Hook we guarantee free replacement including freight

### Installation

With the Bi-Mount™ System installation is simple. Just screw the Bi-Mount™ extruded aluminum mounting hardware flush to the wall, or to brackets in the door jamb, or onto any special mounting hardware. Then slide the J-Hook mounted strips into place and tighten the clamping bolts. Strips will hang straight and level every time, with the proper overlap pre-set.

Available strips:

- Standard.
- USDA Safety Orange.
- Amber Weld.
- Colorview.
- Anti Static

# TRAFFIC DOORS - STRIP

## Heat-Sealed Strip/J-Hook Mount

Strips simply clip into the Bi-mount™ hardware on J-Hook hangers and are clamped securely into position

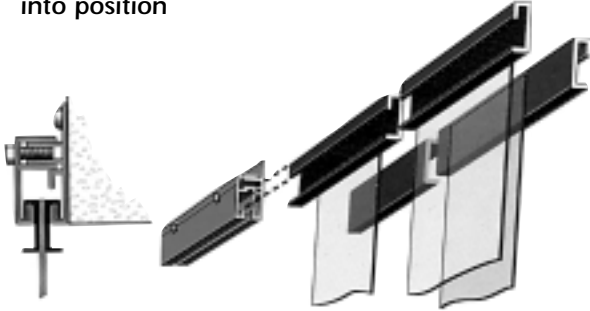

## Pin/Clip Strip Mounting

Pins slide into the hardware. Individual overlapping strips are then attached to the pins and locked into place.

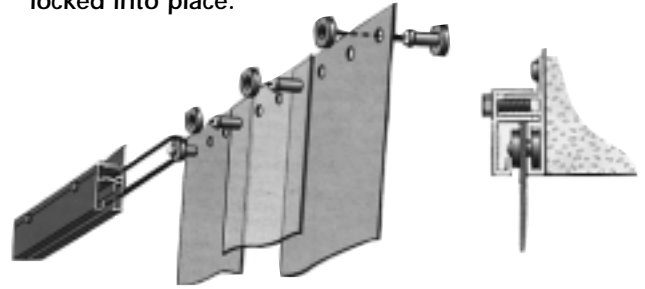

### Bi-mount™ Strip Door Features

- 50%-80% Stronger Mounting
- Easier Field Maintenance
- Corrosive Resistant Aluminum Hardware
- Least Time Consuming Installation
- Largest Material Selection Available

### Strip Door Maintenance

Our Bi-mount™ hardware is revolutionizing the strip door industry. The Bi-mount™ system combines the superior strength of heat sealed mount with the ease of bulk roll maintenance. Order the door with the heat sealed "J" hook hardware for the least time consuming installation and still repair the door by pulling replacement strips right off your bulk roll. You can stock strip material in rolls for immediate repair and maintenance.

### Only Bi-mount™ Hardware Supports Both Pin-Mount and Heat-Sealed strips

The Unique Bi-Mount™ system is a 2-part extruded aluminum bracket designed to accommodate both our popular heat-sealed J - Hook mounted strips and our convenient pin mounted strips.

J-hook mounted strips feature a continuous welded bond between the strips full width and the J-hook. This method reduces stress points and leads to longer life and still allows users to lift out strips for replacement.

The pin mount system utilizes the same Bi-Mount™ hardware but gives the users the ability to make their own strips.

*Standard vinyl strips have a convex shape. This allows each strip to seal to the one next to it, ensuring a better seal.*

*Loc-Rib™ Strips - For scratch and abrasion resistance.*



**Freight Included!**

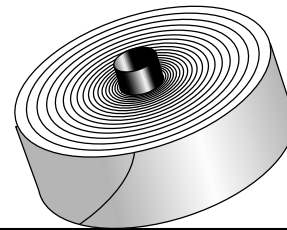

**Freight Included!**

### Complete Doors

Door Width	Size Height	Strip Width	Strip gauge	% over-lap	Price
4'	7'	4"	0.06	50	\$112
6'	7'	4"	0.06	50	\$174
4'	7'	6"	0.06	33	\$124
4'	7'	6"	0.06	67	\$163
6'	8'	8"	0.08	50	\$196
6'	8'	8"	0.08	75	\$215
8'	8'	12"	0.12	50	\$311
8'	8'	12"	0.12	100	\$373
10'	10'	12"	0.12	50	\$467
10'	10'	12"	0.12	100	\$551
12'	12'	12"	0.12	50	\$653
12'	12'	12"	0.12	100	\$768

Prices include Bi-Mount™ hardware, Heat Sealed Mounts & Fasteners

### Other Sizes Available

USDA/Low temperature	add 10%
LOC-RIB	add 25%
USDA/Low temperature Loc-Rib	add 35%
Amber-tint (welding screen)	add 8%
Runway hardware	See Page 45

### Bulk Rolls

#### Description

#### Price/Roll

4" X .060 X 300' Std.....	\$102.00
6" X .060 X 300' Std.....	\$144.00
8" X .080 X 300' Std.....	\$220.00
12" X .120 X 150' Std.....	\$245.00
12" X .120 X 200' Std.....	\$326.00

**Add for Low Temperature ..... 15%**

\*Bi-Mounting Strip Door Hardware

For Pin & Clips included .....\$10.15 + fr.

\*J-Hook- Aluminum Extrusion Only .....\$8.10+ fr.

Pins & Clips (Need 6 per ft).....40c ea.

Freight not included on strip door hardware

### Loc-Rib™ Bulk Rolls

8" X .080 X 150' Std.....\$145.00

12" X .120 X 150' Std.....\$329.00

Call for pricing on amberweld, safety orange, color view and 48" wide materials.